

CS-BEVELS FACETTEN

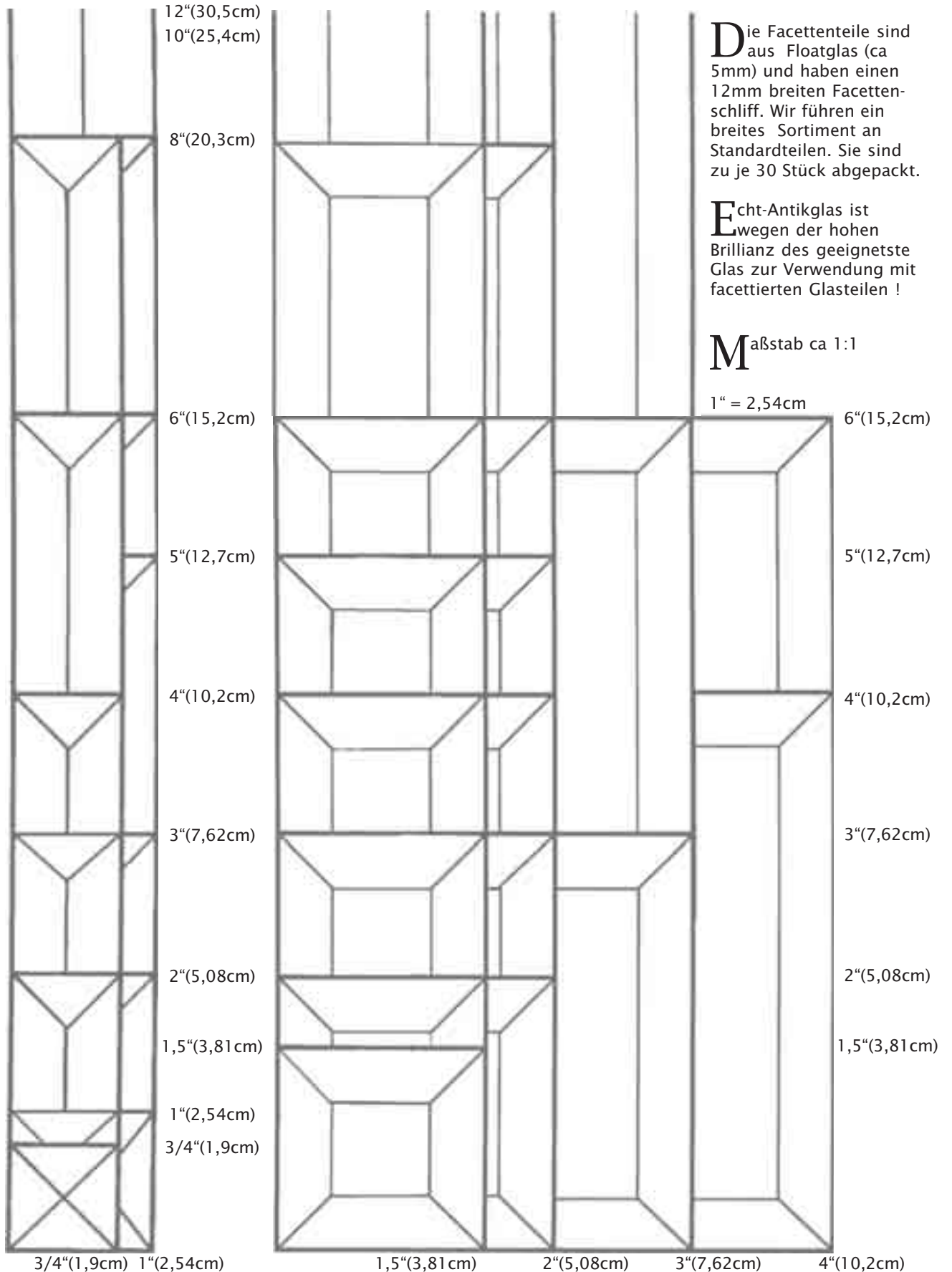

Die Facettenteile sind aus Floatglas (ca 5mm) und haben einen 12mm breiten Facettenschliff. Wir führen ein breites Sortiment an Standardteilen. Sie sind zu je 30 Stück abgepackt.

Echt-Antikglas ist wegen der hohen Brillanz des geeignetste Glas zur Verwendung mit facettierten Glasteilen !

Maßstab ca 1:1

1" = 2,54cm

CS-BEVELS

FACETTEN

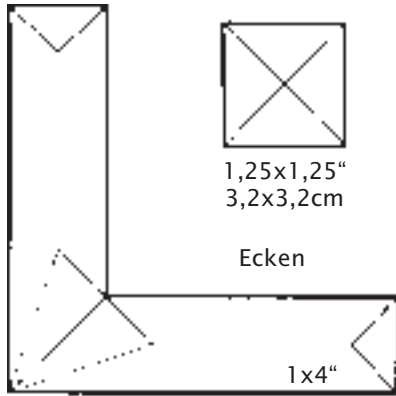

Ecken

1x4"

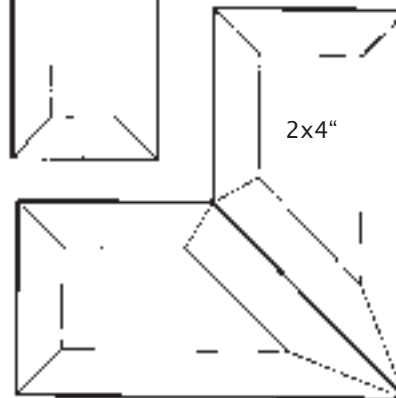
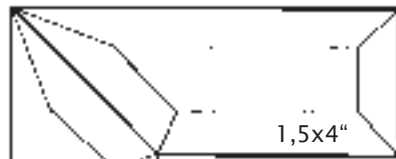

Maßstab ca 1:2

- 1" = 2,54cm
- 2" = 5,08cm
- 3" = 7,72cm
- 4" = 10,2cm
- 5" = 12,7cm
- 6" = 15,2cm
- 9" = 22,9cm
- 10" = 25,4cm
- 12" = 30,5cm

Weitere Bevels ohne Abbildung - auf Anfrage

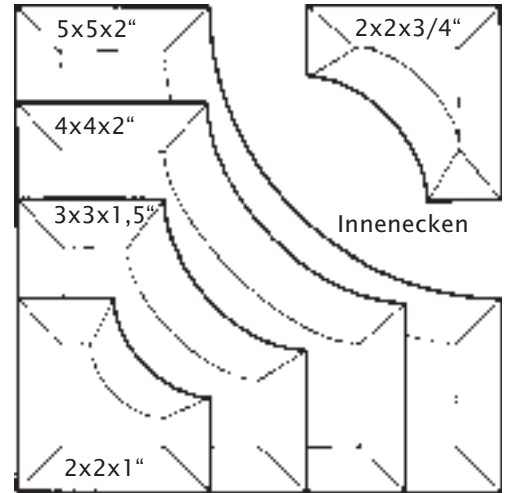

Kreise

5" & 6" o.Abb.

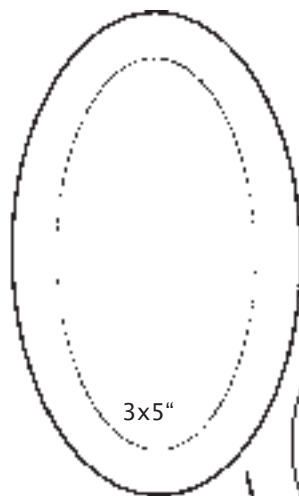
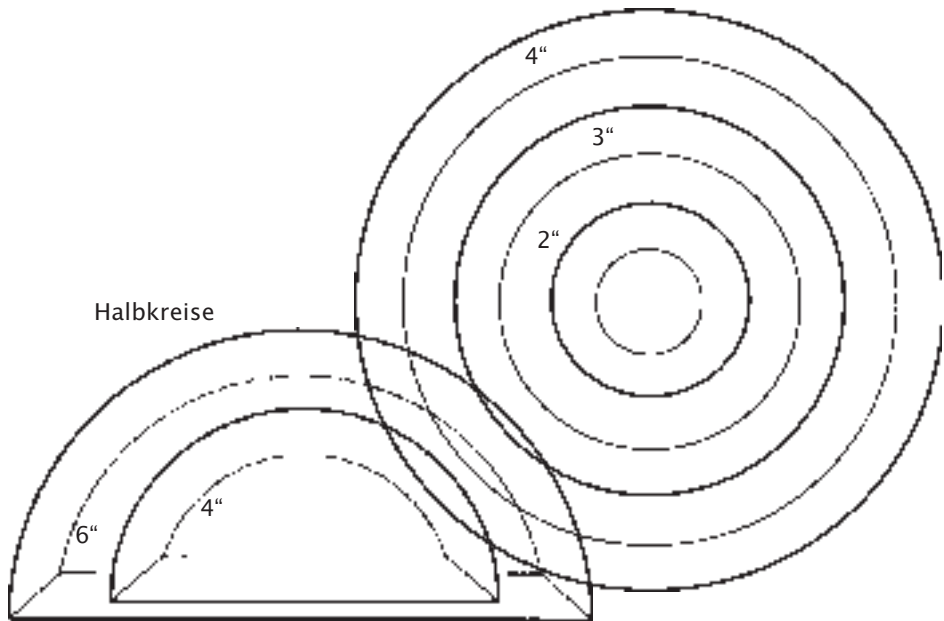

Ovale

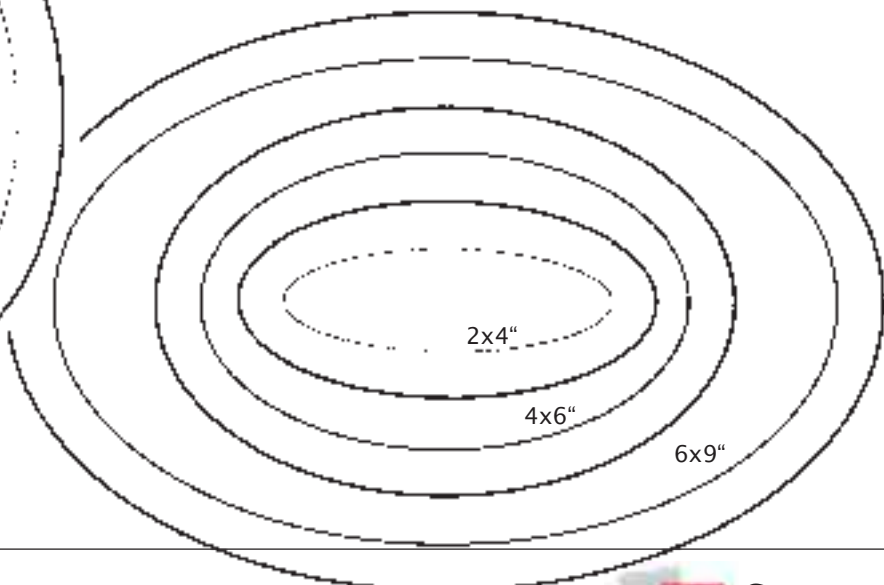

CS-BEVELS

FACETTEN

Maßstab ca 1:2

1" = 2,54cm
 2" = 5,08cm
 3" = 7,72cm
 4" = 10,2cm
 5" = 12,7cm
 6" = 15,2cm
 9" = 22,9cm
 10" = 25,4cm
 12" = 30,5cm

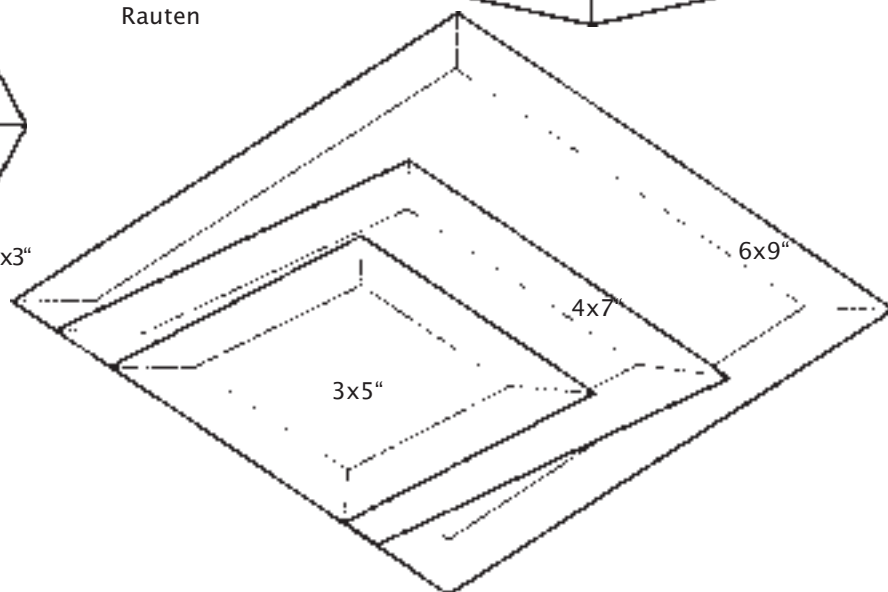
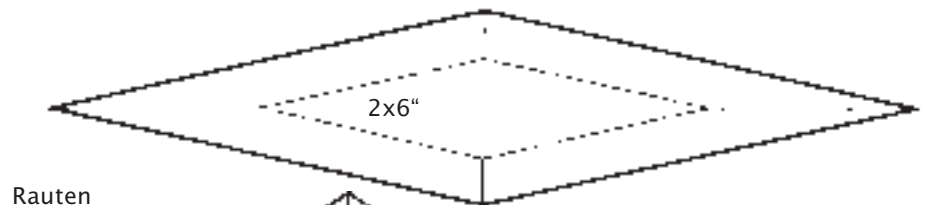
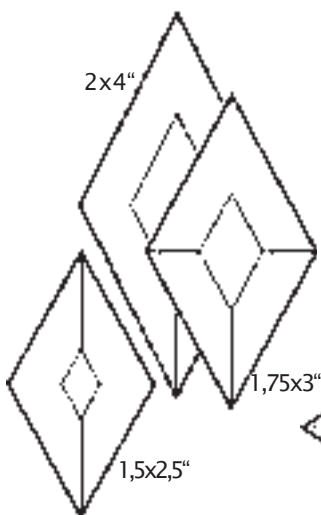
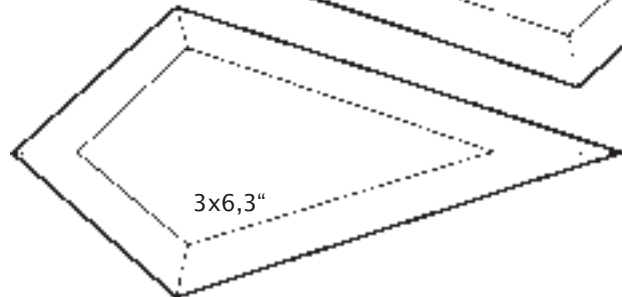
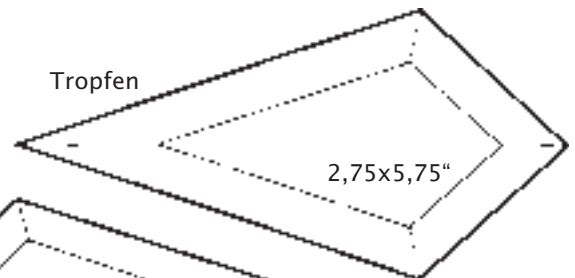
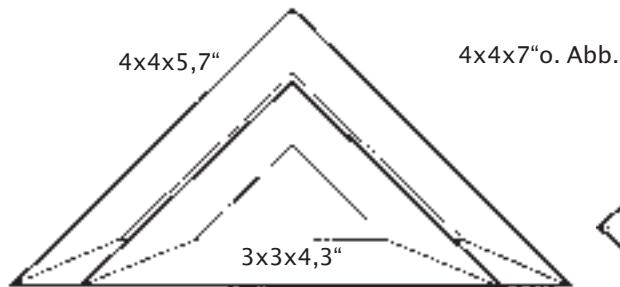
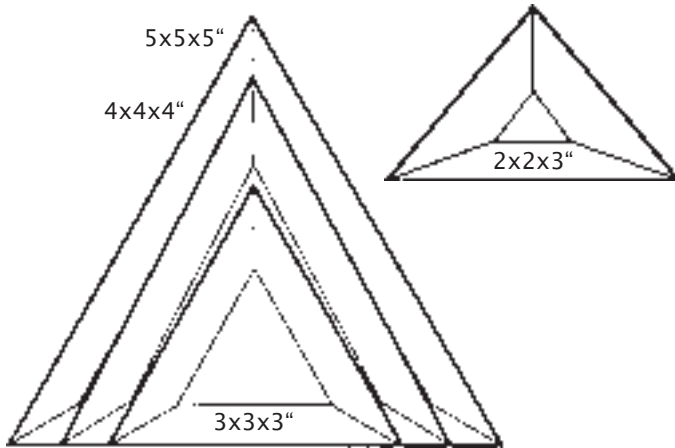

Bevels sind zu je 30 Stück abgepackt.

Weitere Bevels ohne Abbildung
 - auf Anfrage !

CS-BEVELS

FACETTEN

Fünfecke

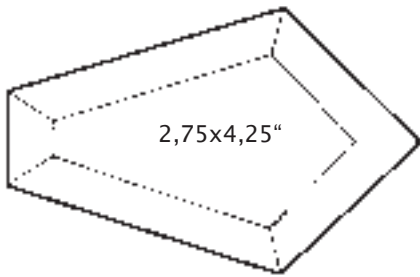
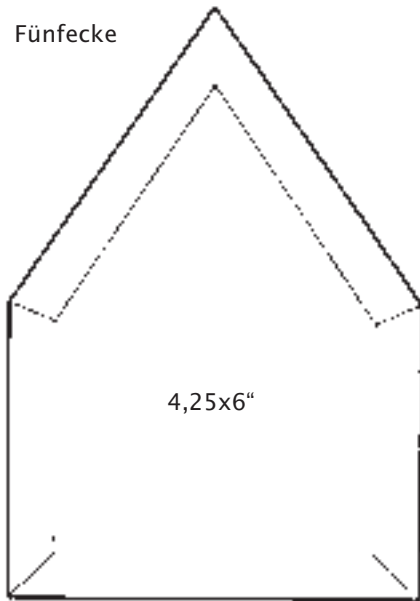

Sechseck

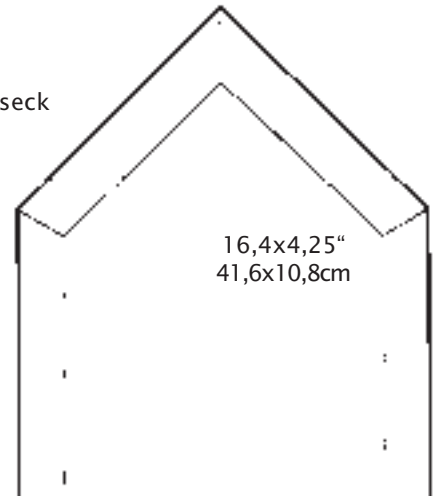

Maßstab ca 1:2

1"	= 2,54cm
2"	= 5,08cm
3"	= 7,72cm
4"	= 10,2cm
5"	= 12,7cm
6"	= 15,2cm
9"	= 22,9cm
10"	= 25,4cm
12"	= 30,5cm

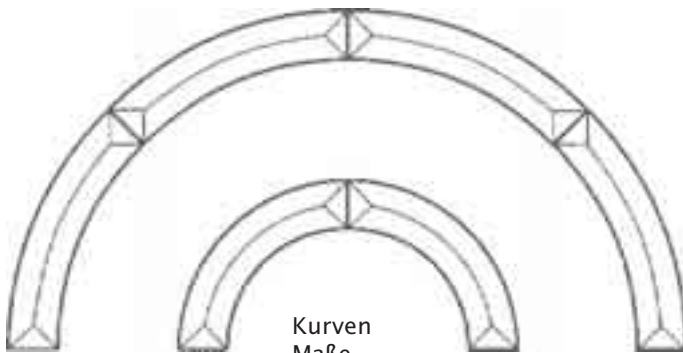

Kurven
Maße ,
Innenradius &
Aussenradius:
IR 6" - AR 7"
IR 9" - AR 10"
IR 12" - AR 13"
IR 15" - AR 16"

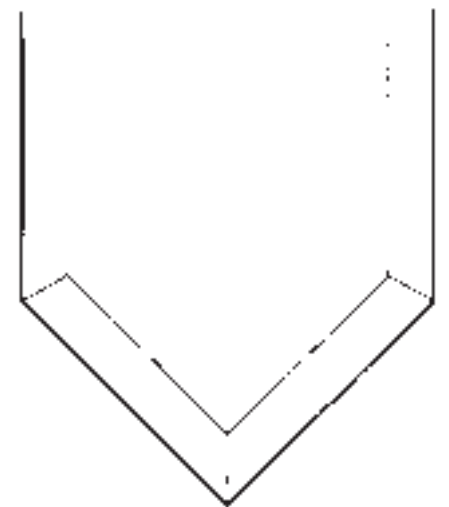

Weitere Bevels ohne Abbildung -
auf Anfrage !

CS-BEVELS

SPIEGEL-FACETTEN

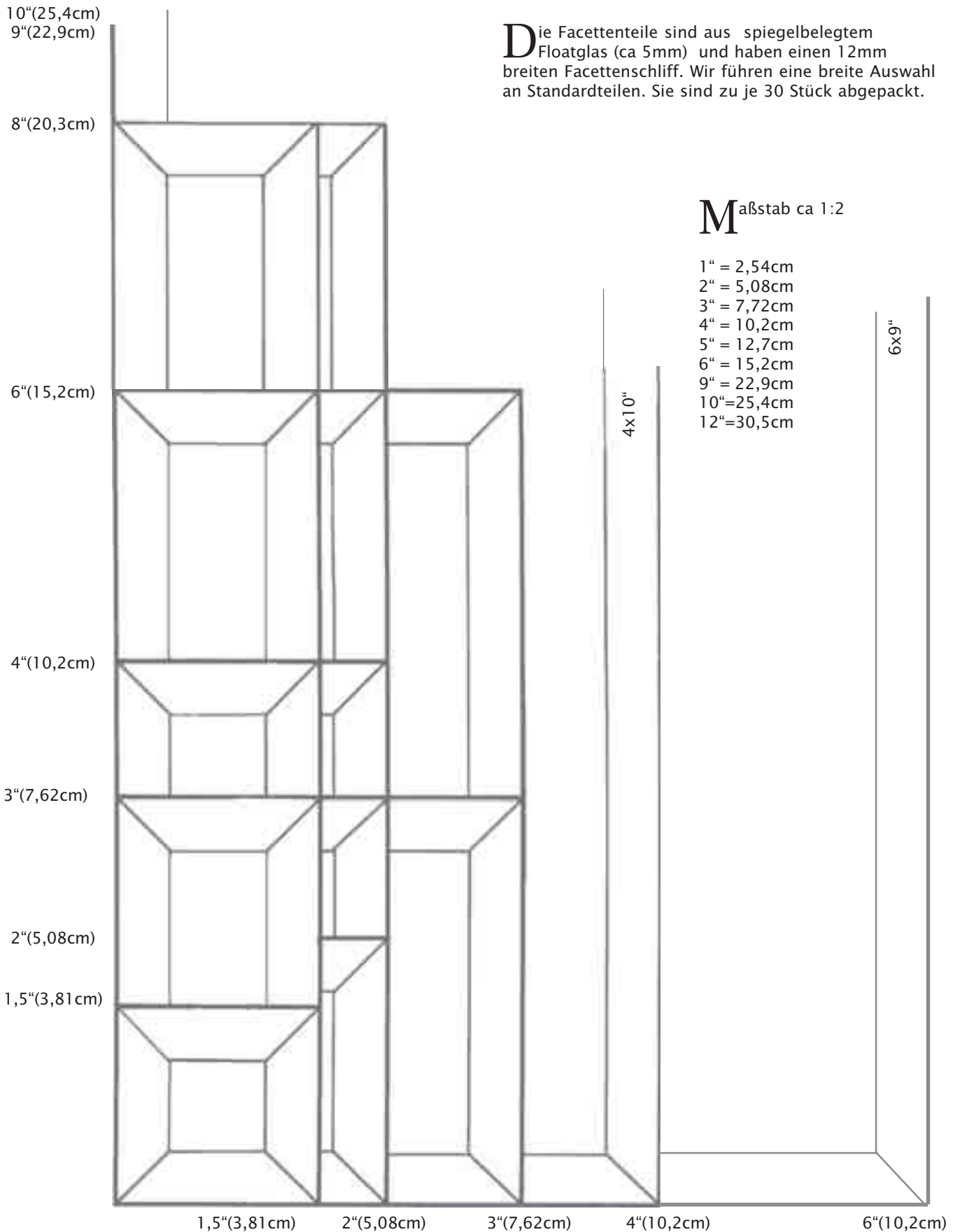

CS-BEVELS SPIEGEL-FACETTEN

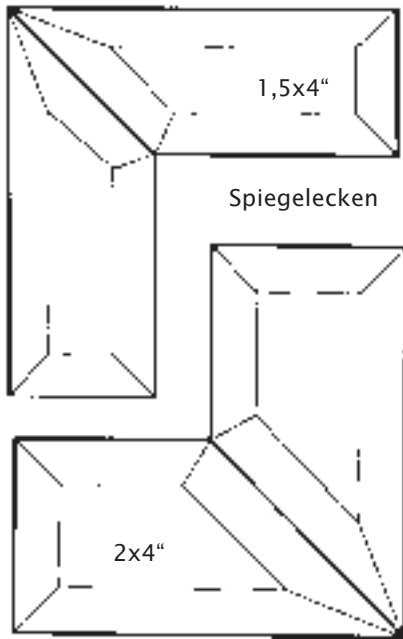

Spiegelecken

Spiegelkreise

5" & 6" o.Abb.

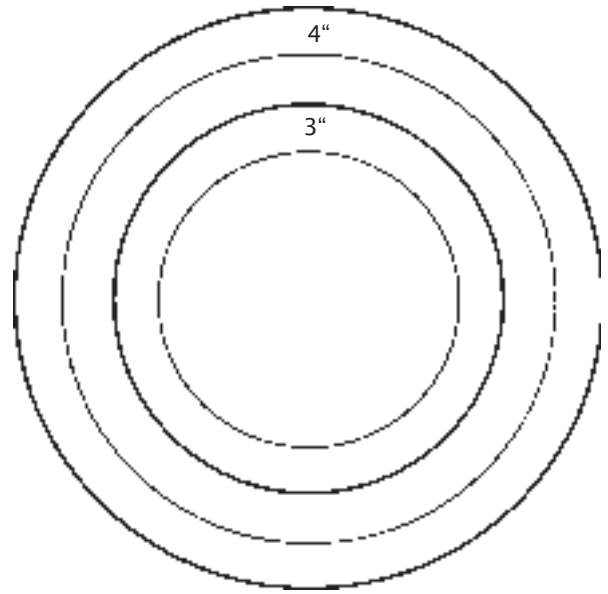

Spiegeldreiecke

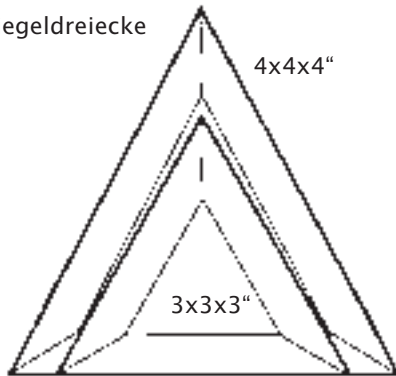

Weitere Spiegelrauten
ohne Abbildung

3x5"
4x7"
9,8x4,25"

Mmaßstab: ca 1:2 bzw
auf dieser Seite ohne
Maßstab abgebildet !

1" = 2,54cm
2" = 5,08cm
3" = 7,72cm
4" = 10,2cm
5" = 12,7cm
6" = 15,2cm
9" = 22,9cm

8-Eck-Spiegel 7,5" (19,2cm) ohne Abbildung

Weitere Bevels ohne Abbildung
- auf Anfrage !